

Varenummer: 40600852932425

Beskrivelse: Tandhjulsgeær C804F-529,3-P71B5

Mål

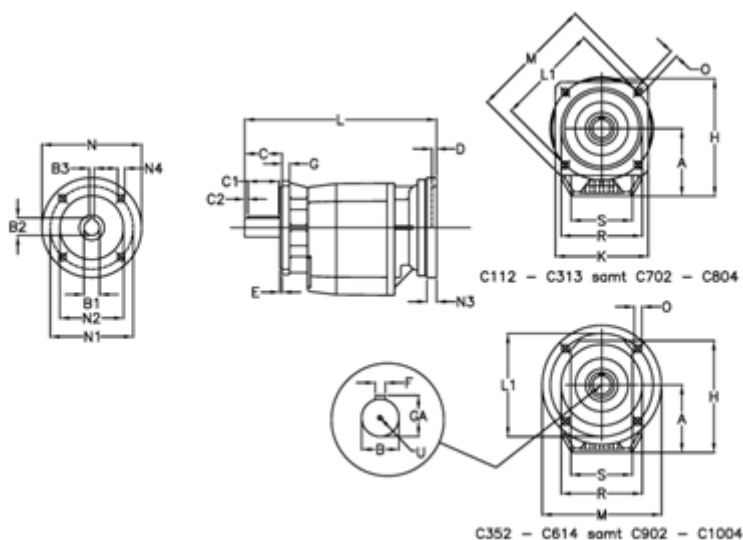

A = 247.0	D = 4.5	L1 = 350	R = 320
B = 80	E = 5	M = 400	S = 300
B1 = 14	F = 22	N = 160	U = M20x42
B2 = 16.3	G = 20	N1 = 130	
B3 = 5	GA = 85.0	N2 = 110	
C = 140	H = 422.0	N3 = 0	
C1 = 110	K = 350	N4 = M8x16	
C2 = 15	L = 576.5	O = 18.0	